

# ORGA-LINE

for TANDEMBOX

Technical data sheet





## Contents

### ORGA-LINE for drawers

- 04 Container sets
- 06 Utensil divider sets
- 08 Combo sets
- 09 Individual sets

### ORGA-LINE for high fronted pull-outs

- 11 Colour range

### TANDEMBOX intivo

- 12 Single parts
- 14 Inner dividing system sets

### TANDEMBOX antaro

- 15 Single parts
- 16 Cross gallery
- 17 Cross divider

### TANDEMBOX plus

- 18 Single parts
- 19 Gallery
- 20 BOXSIDE

### ORGA-LINE kitchen accessories

- 21 Description



Container sets

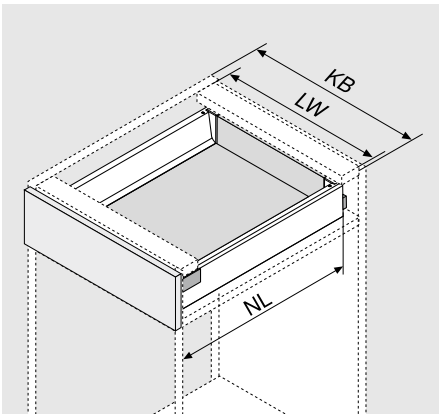

- Container sets are especially practical for use in the kitchen
- Ideal for cutlery
- For drawers and inner drawers with cabinet widths 275 to 1200 mm
- Available in all nominal lengths from 450 to 550 mm
- Removable dishwasher-proof containers
- Can be combined with a film/foil dispenser or knife holder

Ordering information

Cabinet width 275 – 349 mm	
NL (mm)	
450	ZSI.450B1N
500	ZSI.500B1N
550	ZSI.550B1N

Cabinet width 350 – 449 mm	
NL (mm)	
450	ZSI.450B2N
500	ZSI.500B2N
550	ZSI.550B2N

Cabinet width 450 mm	
NL (mm)	
450	ZSI.45VE14
500	ZSI.45VE16
550	ZSI.45VE17

Cabinet width 451 – 499 mm	
NL (mm)	
450	ZSI.450B3N
500	ZSI.500B3
550	ZSI.550B3

Cabinet width 500 mm	
NL (mm)	
450	ZSI.50VE14
500	ZSI.50VE16
550	ZSI.50VE17

Cabinet width 501 – 549 mm	
NL (mm)	
450	ZSI.450B3N
500	ZSI.500B3
550	ZSI.550B3

Cabinet width 550 mm	
NL (mm)	
450	ZSI.55VE14
500	ZSI.55VE16
550	ZSI.55VE17

Cabinet width 551 – 599 mm	
NL (mm)	
450	ZSI.450K14N
500	ZSI.500K14
550	ZSI.550K14

Cabinet width 600 mm	
NL (mm)	
450	ZSI.60VE14
500	ZSI.60VE16
550	ZSI.60VE17

KB Cabinet width  
 LW Internal cabinet width  
 NL Nominal length

◀ Set fills drawer

Ordering information

**Cabinet width 601 – 799 mm**



NL (mm)	
450	ZSI.450BI1N + ZSI.450BI3N
500	ZSI.500BI1N + ZSI.500BI3
550	ZSI.550BI1N + ZSI.550BI3

**Cabinet width 800 mm**



NL (mm)	
450	ZSI.80VE14
500	ZSI.80VE16
550	ZSI.80VE17

**Cabinet width 801 – 899 mm**



NL (mm)	
450	2 x ZSI.450BI3N
500	2 x ZSI.500BI3
550	2 x ZSI.550BI3

**Cabinet width 900 mm**

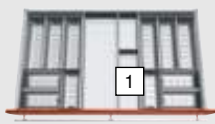

NL (mm)	
450	ZSI.90VE14
500	ZSI.90VE16
550	ZSI.90VE17

**Cabinet width 901 – 999 mm**



NL (mm)	
450	ZSI.450BI3N + ZSI.450K14N
500	ZSI.500BI3 + ZSI.500K14
550	ZSI.550BI3 + ZSI.550K14

**Cabinet width 1000 mm**

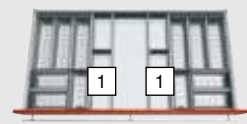

NL (mm)	
450	ZSI.10VE14
500	ZSI.10VE16
550	ZSI.10VE17

**Cabinet width 1001 – 1199 mm**

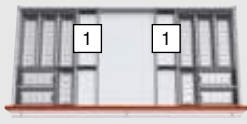

NL (mm)	
450	2 x ZSI.450K14N
500	2 x ZSI.500K14
550	2 x ZSI.550K14

**Cabinet width 1200 mm**

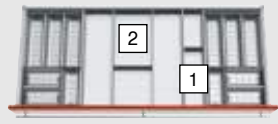

NL (mm)	
450	ZSI.12VE14
500	ZSI.12VE16
550	ZSI.12VE17

**SPACE CORNER**



NL (mm)	
600	ZSI.450BI3E
650	ZSI.500BI3E

NL Nominal length

◀ Set fills drawer

1 2 Please see page 10 for more information about the knife holder and film/foil dispenser.

Utensil divider sets

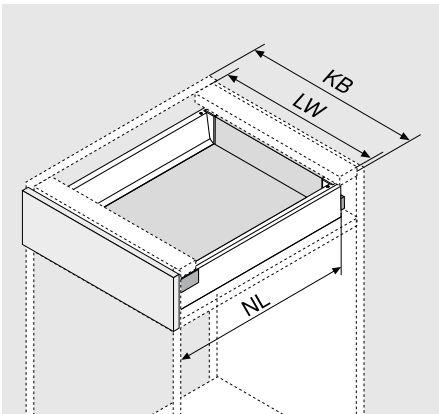

- Utensil divider sets are practical for use in the kitchen and in other areas of the home
- For drawers and inner drawers with cabinet widths 275 to 1200 mm
- Available in all nominal lengths from 450 to 550 mm
- Removable dishwasher-proof containers
- Can be combined with a film/foil dispenser or knife holder

Ordering information

Cabinet width 275 – 349 mm	
NL (mm)	
450	ZSI.450B11N
500	ZSI.500B11N
550	ZSI.550B11N

Cabinet width 350 – 449 mm	
NL (mm)	
450	ZSI.450K12N
500	ZSI.500K12N
550	ZSI.550K12N

Cabinet width 450 – 599 mm	
NL (mm)	
450	ZSI.450F12N
500	ZSI.500F12N
550	ZSI.550F12N

Cabinet width 600 mm	
NL (mm)	
450	ZSI.60VU14
500	ZSI.60VU16
550	ZSI.60VU17

Cabinet width 601 – 699 mm	
NL (mm)	
450	ZSI.450B11N + ZSI.450K13N
500	ZSI.500B11N + ZSI.500K13N
550	ZSI.550B11N + ZSI.550K13N

Cabinet width 700 – 799 mm	
NL (mm)	
450	ZSI.450K12N + ZSI.450K13N
500	ZSI.500K12N + ZSI.500K13N
550	ZSI.550K12N + ZSI.550K13N

Cabinet width 800 mm	
NL (mm)	
450	ZSI.80VU14
500	ZSI.80VU16
550	ZSI.80VU17

Cabinet width 801–899 mm	
NL (mm)	
450	2 x ZSI.450K13N
500	2 x ZSI.500K13N
550	2 x ZSI.550K13N

Cabinet width 900 mm	
NL (mm)	
450	ZSI.90VU14
500	ZSI.90VU16
550	ZSI.90VU17

- KB Cabinet width
- LW Internal cabinet width
- NL Nominal length

Set fills drawer

Ordering information

**Cabinet width 901 – 999 mm**

NL (mm)	
450	2 x ZSI.450KI3N
500	2 x ZSI.500KI3N
550	2 x ZSI.550KI3N

**Cabinet width 1000 mm**

NL (mm)	
450	ZSI.10VU14
500	ZSI.10VU16
550	ZSI.10VU17

**Cabinet width 1001 – 1099 mm**

NL (mm)	
450	2 x ZSI.450KI2N + ZSI.450F13
500	2 x ZSI.500KI2N + ZSI.500F13
550	2 x ZSI.550KI2N + ZSI.550F13

**Cabinet width 1100 – 1199 mm**

NL (mm)	
450	2 x ZSI.450KI3N + ZSI.450F12
500	2 x ZSI.500KI3N + ZSI.500F12
550	2 x ZSI.550KI3N + ZSI.550F12

**Cabinet width 1200 mm**

NL (mm)	
450	ZSI.12VU14
500	ZSI.12VU16
550	ZSI.12VU17

**SPACE CORNER**

NL (mm)	
600	ZSI.450F13
650	ZSI.500F13

NL Nominal length

Set fills drawer

**1** **2** Please see page 10 for more information about the knife holder and film/foil dispenser.

Combo sets

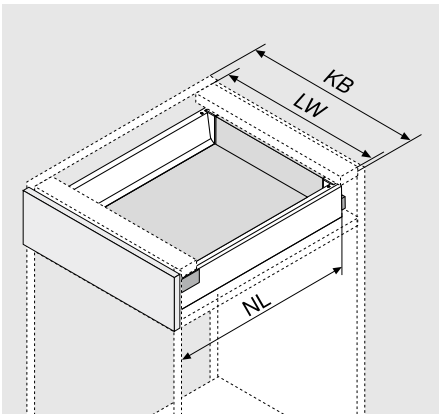

- These sets are a combination of utensil dividers and containers and are ideal for kitchens and living areas
- For drawers and inner drawers with cabinet widths 275 to 1200 mm
- Available in all nominal lengths from 450 to 550 mm
- Removable dishwasher-proof containers
- Can be combined with a film/foil dispenser or knife holder

Ordering information

Cabinet width 275 – 349 mm	
NL (mm)	
450	ZSI.450B1N
500	ZSI.500B1N
550	ZSI.550B1N

Cabinet width 350 – 449 mm	
NL (mm)	
450	ZSI.450KI2N
500	ZSI.500KI2N
550	ZSI.550KI2N

Cabinet width 450 – 600 mm	
NL (mm)	
450	ZSI.450MI3
500	ZSI.500MI3
550	ZSI.550MI3

Cabinet width 601 – 649 mm	
NL (mm)	
450	ZSI.450B1N + ZSI.450MI3
500	ZSI.500B1N + ZSI.500MI3
550	ZSI.550B1N + ZSI.550MI3

Cabinet width 650 – 750 mm	
NL (mm)	
450	ZSI.450KI2N + ZSI.450MI3
500	ZSI.500KI2N + ZSI.500MI3
550	ZSI.550KI2N + ZSI.550MI3

Cabinet width 751 – 899 mm	
NL (mm)	
450	ZSI.450KI3N + ZSI.450BI3N
500	ZSI.500KI3N + ZSI.500BI3
550	ZSI.550KI3N + ZSI.550BI3

Cabinet width 900 – 1200 mm	
NL (mm)	
450	ZSI.450KI3N + ZSI.450KI4N
500	ZSI.500KI3N + ZSI.500KI4
550	ZSI.550KI3N + ZSI.550KI4

SPACE CORNER	
NL (mm)	
600	ZSI.450F13
650	ZSI.500F13

KB	Cabinet width
LW	Internal cabinet width
NL	Nominal length

1 2 Please see page 10 for more information about the knife holder and film/foil dispenser.

**Individual sets**

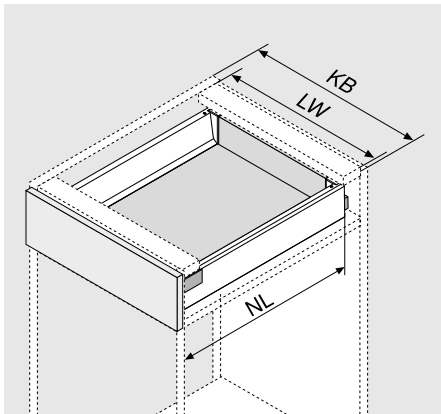

- These adjustable partial width sets are suitable for use in the kitchen and in other living areas
- For drawers and inner drawers in different cabinet widths
- Available in all nominal lengths from 450 to 550 mm
- Sets include utensil dividers, containers or a combination of the two
- Removable dishwasher-proof containers
- Can be combined with a film/foil dispenser or knife holder

**Ordering information**

**Set B11**

NL (mm)	
450	ZSI.450B11N
500	ZSI.500B11N
550	ZSI.550B11N

**Set B12**

NL (mm)	
450	ZSI.450B12N
500	ZSI.500B12N
550	ZSI.550B12N

**Set B13**

NL (mm)	
450	ZSI.450B13N
500	ZSI.500B13
550	ZSI.550B13

**Set K12**

NL (mm)	
450	ZSI.450K12N
500	ZSI.500K12N
550	ZSI.550K12N

**Set K13**

NL (mm)	
450	ZSI.450K13N
500	ZSI.500K13N
550	ZSI.550K13N

**Set K14**

NL (mm)	
450	ZSI.450K14N
500	ZSI.500K14
550	ZSI.550K14

KB	Cabinet width
LW	Internal cabinet width
NL	Nominal length

Ordering information

**Set MI3**

Nominal length NL (mm)	
450	ZSI.450MI3
500	ZSI.500MI3
550	ZSI.550MI3

**Set FI2**

Nominal length NL (mm)	
450	ZSI.450FI2N
500	ZSI.500FI2N
550	ZSI.550FI2N

**Set FI3**

Nominal length NL (mm)	
450	ZSI.450FI3
500	ZSI.500FI3
550	ZSI.550FI3

**Set BI3E for SPACE CORNER**

Nominal length NL (mm)	
600	ZSI.450BI3E
650	ZSI.500BI3E

**Adjustable cross dividers**

Width (mm)	
88	ZSI.010Q
176	ZSI.020Q

**Containers**

Size (mm)	
88 x 88	ZSI.010SI
88 x 176	ZSI.020SI
88 x 264	ZSI.030SI
88 x 352	ZSI.040SI

**Film/foil dispenser**

For cling film	
Incl. film	ZSZ.01F0
Without film	ZSZ.01F1

1	1 x ZSZ.01F0
2	1 x ZSZ.01F0 + 1 x ZSZ.02F0

**Film/foil dispenser**

For aluminium foil	
Incl. foil	ZSZ.02F0
Without foil	ZSZ.02F1

1	1 x ZSZ.02F0
2	1 x ZSZ.01F0 + 1 x ZSZ.02F0

**Knife holder**

For 9 knives	ZSZ.02M0
2	1 x ZSZ.02M0

**i Placement of kitchen accessories**

Colour range

ORGA-LINE for TANDEMBOX intivo and antaro high fronted pull-outs

Colours
<b>SW</b>
Silk white
<b>R9006</b>
RAL9006 grey (white aluminium)
<b>NI</b>
Nickel plated
<b>R9006 / WGR</b>
RAL9006 grey (white aluminium) / white grey

Further colours
<b>INGL</b>
Anti-fingerprint stainless steel
<b>WGR</b>
White grey
<b>R7037</b>
RAL7037 dust grey

ORGA-LINE for TANDEMBOX plus high fronted pull-outs

Colours
<b>SW</b>
Silk white
<b>R9006</b>
RAL9006 grey (white aluminium)
<b>NI</b>
Nickel plated
<b>R9001</b>
Cream
<b>R9006 / WGR</b>
RAL9006 grey (white aluminium) / white grey

Further colours
<b>INGL</b>
Anti-fingerprint stainless steel
<b>WGR</b>
White grey
<b>R7037</b>
RAL7037 dust grey

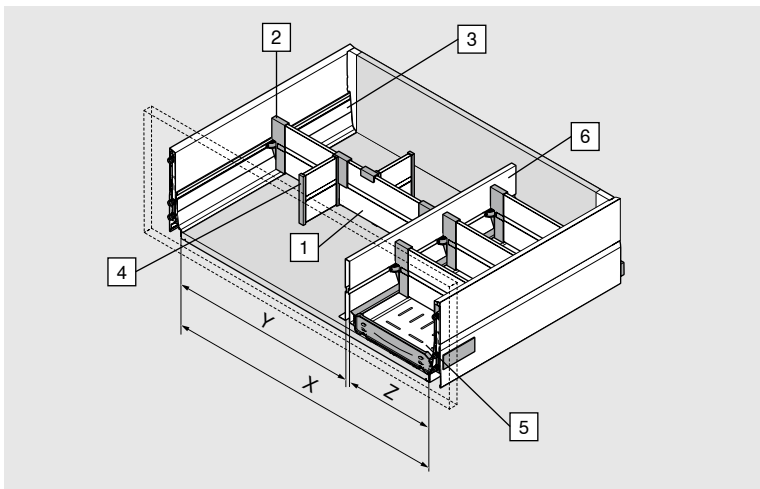



Single parts

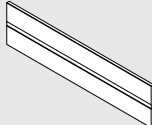

Ordering information

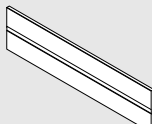
	<b>1</b> <b>Cross divider – cut to size</b>			
	<b>Colours</b>		SW	R9006
	<b>Cabinet width KB (mm)</b>		Steel	
	300		Z40L177S	
	400		Z40L277S	
	450		Z40L327S	
	500		Z40L377S	
	550		Z40L427S	
	700		Z40L577S	
	750		Z40L627S	
	800		Z40L677S	
	900		Z40L777S	
	1000		Z40L877S	
1200		Z40L1077S		

	<b>1</b> <b>Cross divider for cutting to size</b>				
	<b>Colours</b>		SW	R9006	NI
	<b>Length (mm)</b>		Aluminium		
	1077		Z40L1077A		
	<b>Cutting:</b>		X LW - 91 mm Y LW - 295 mm (KB 275 mm)      Y LW - 320 mm (KB 300 mm) Z 152 mm (KB 275 mm)              Z 177 mm (KB 300 mm)		

	<b>2</b> <b>Cross divider connector</b>				
	<b>Colours</b>		SW	R9006	NI
			Nylon		
		Z40L0002			

KB	Cabinet width
LW	Internal cabinet width

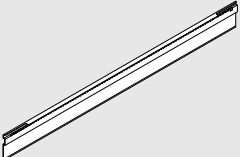

Ordering information

	<b>3 Adapter profile for cross divider</b>		
	Colours	SW	R9006
	Nominal length NL (mm)	Steel	
	270	Z49L242S	
	300	Z49L272S	
	350	Z49L322S	
	400	Z49L372S	
	450	Z49L422S	
	500	Z49L472S	
550	Z49L522S		

	<b>4 Lateral divider</b>		
	Colours	SW	R9006
		Steel	
	Z43L100S		

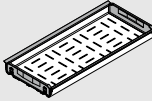
	<b>5 Bottle rack</b>		
	Nominal length NL (mm)	Cabinet width KB 275 mm	Cabinet width KB 300 mm
	450		Z48.30B014
	500	Z48.27B016	Z48.30B016
	550	Z48.27B017	Z48.30B017

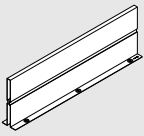
	<b>6 Dividing wall</b>		
	Colours	SW	R9006
	Nominal length NL (mm)	Steel	
	450	Z46L420S	
	500	Z46L470S	
550	Z46L520S		

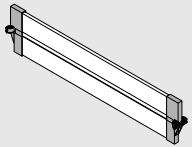
<b>Cross divider cut to size and pre-mounted</b>			
	Colours	SW	R9006
	Cabinet width KB (mm)	Steel	
	300	Z40L177S	
	400	Z40L277S	
	450	Z40L327S	
	500	Z40L377S	
	550	Z40L427S	
	700	Z40L577S	
	750	Z40L627S	
	800	Z40L677S	
	900	Z40L777S	
	1000	Z40L877S	
	1200	Z40L1077S	



Inner dividing system sets

Ordering information

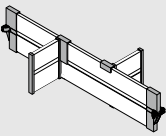
Cross and lateral divider set			
	For nominal lengths of 450 mm		
	Colours	SW	R9006
	Cabinet width KB (mm)	Steel	
	275	ZFL.27BUS4	ZFL.27BUS4
	300	ZFL.30BUS4	ZFL.30BUS4
	400	ZFL.40BUS4	ZFL.40BUS4
	450	ZFL.45BUS4	ZFL.45BUS4
	500	ZFL.50BUS4	ZFL.50BUS4
	550	ZFL.55BUS4	ZFL.55BUS4
	800	ZFL.80BUS4	ZFL.80BUS4
900	ZFL.90BUS4	ZFL.90BUS4	
1000	ZFL.10BUS4	ZFL.10BUS4	
1200	ZFL.12BUS4	ZFL.12BUS4	

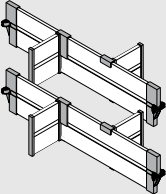
Cross and lateral divider set			
	Nominal length from 500 mm		
	Colours	SW	R9006
	Cabinet width KB (mm)	Steel	
	275	ZFL.27BUS6	ZFL.27BUS6
	300	ZFL.30BUS6	ZFL.30BUS6
	400	ZFL.40BUS6	ZFL.40BUS6
	450	ZFL.45BUS6	ZFL.45BUS6
	500	ZFL.50BUS6	ZFL.50BUS6
	550	ZFL.55BUS6	ZFL.55BUS6
	800	ZFL.80BUS6	ZFL.80BUS6
900	ZFL.90BUS6	ZFL.90BUS6	
1000	ZFL.10BUS6	ZFL.10BUS6	
1200	ZFL.12BUS6	ZFL.12BUS6	

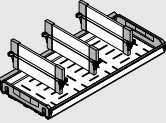
Bottle set			
	Colours	SW	R9006
	Nominal length NL (mm)	Steel	
	450	ZFL.30BFS4	
	500	ZFL.30BFS6	
550	ZFL.30BFS7		



Single parts

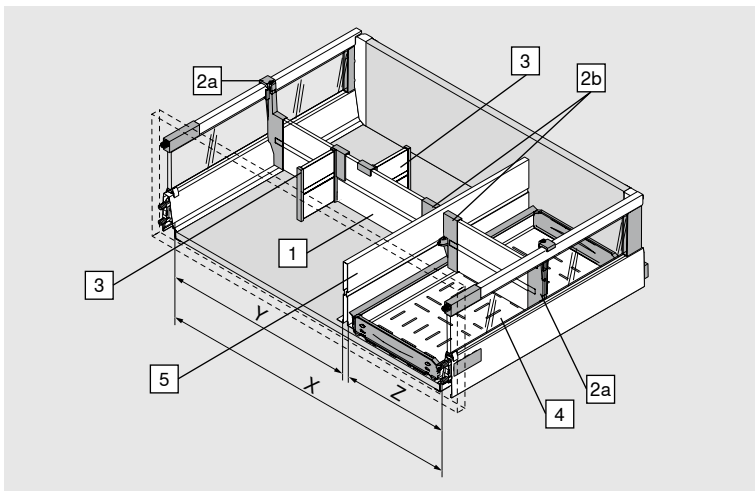

Ordering information

	<b>1</b>			<b>Cross divider cut to size</b>		
	<b>Colours</b>		SW	R9006		
	<b>Cabinet width KB (mm)</b>		Steel			
	300	Z40L177S		Z40L177S		
	400	Z40L277S		Z40L277S		
	450	Z40L327S		Z40L327S		
	500	Z40L377S		Z40L377S		
	550	Z40L427S		Z40L427S		
	600	Z40L477S		Z40L477S		
	800	Z40L677S		Z40L677S		
	900	Z40L777S		Z40L777S		
	1000	Z40L877S		Z40L877S		
1200	Z40L1077S		Z40L1077S			

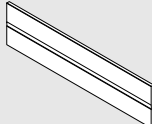

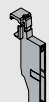
	<b>1</b>				<b>Cross divider for cutting to size</b>	
	<b>Colours</b>		SW	R9006	NI	
	<b>Length (mm)</b>		Aluminium			
	1077		Z40L1077A			
	<b>Cutting:</b>		X LW - 91 mm		Y LW - 320 mm (KB 300 mm)	
		Y LW - 295 mm (KB 275 mm)		Z 177 mm (KB 300 mm)		
		Z 152 mm (KB 275 mm)				

	<b>2a</b>				<b>Cross divider connector for gallery</b>	
	<b>Colours</b>		SW	WGR	R7037	
			Nylon			
	<b>Height C</b>		Z40C0002Z			
<b>Height D</b>		Z40D0002Z				

KB	Cabinet width
LW	Internal cabinet width



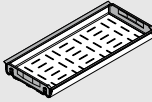
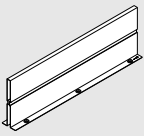

Ordering information

<b>2b</b>				<b>Cross divider connector for dividing wall</b>			
	<b>Colours</b>	SW	R9006	R7037			
		Nylon					
	Z40L0002						
<b>3</b>				<b>Lateral divider</b>			
	<b>Colours</b>	SW		R9006			
		Steel					
	Z43L100S						
<b>4</b>				<b>Bottle rack</b>			
	<b>Nominal length NL (mm)</b>	<b>Cabinet width KB 275 mm</b>		<b>Cabinet width KB 300 mm</b>			
	450			Z48.30B014			
	500	Z48.27B016		Z48.30B016			
	550	Z48.27B017		Z48.30B017			
<b>5</b>				<b>Dividing wall</b>			
	<b>Colours</b>	SW		R9006			
	<b>Nominal length NL (mm)</b>	Steel					
	450	Z46L420S					
	500	Z46L470S					
	550	Z46L520S					

Cross gallery, cut to size

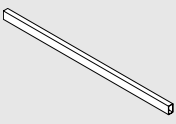
Ordering information

<b>Cross gallery, cut to size</b>					
	<b>Colours</b>	SW	R9006	NI	
	<b>Cabinet width KB (mm)</b>	Aluminium			
	275	ZRG.179Q			
	300	ZRG.204Q			
	550	ZRG.454Q			
	900	ZRG.804Q			
	1200	ZRG.1104Q			
<b>Cross gallery connector</b>					
	<b>Colours</b>	SW	WGR	R7037	
		Nylon			
	ZRU.01E0				
<b>Lateral divider for cross gallery</b>					
	<b>Colours</b>	SW	WGR	R7037	
		Nylon			
	ZRU.11F0				



Cross divider cut to size and pre-mounted

Ordering information





Cross divider cut to size and pre-mounted			
Height C			
	Colours	SW	R9006
	Cabinet width KB (mm)	Steel	
	275	Z40C152S.01	
	300	Z40C177S.01	
	400	Z40C277S.01	
	450	Z40C327S.01	
	500	Z40C377S.01	
	550	Z40C427S.01	
	700	Z40C577S.01	
	800	Z40C677S.01	
	900	Z40C777S.01	
1200	Z40C1077S01		
Height D			
	275	Z40D152S.01	
	300	Z40D177S.01	
	400	Z40D277S.01	
	450	Z40D327S.01	
	500	Z40D377S.01	
	550	Z40D427S.01	
	700	Z40D577S.01	
	800	Z40D677S.01	
	900	Z40D777S.01	
	1200	Z40D1077S01	

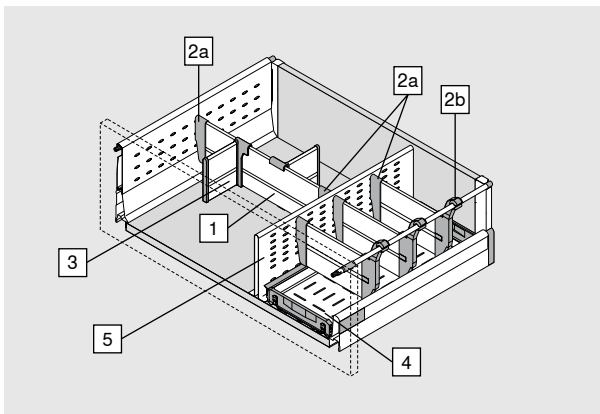

Single parts

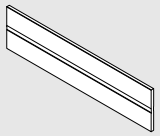

Ordering information

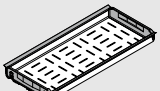
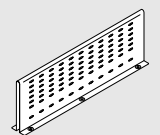

	<b>1</b> Cross divider for cutting to size		
	<b>Colours</b>	R9006	NI
	<b>Length (mm)</b>	Aluminium	
	1077	Z40L1077A	
	<b>Cutting:</b>	X LW - 91 mm	Y LW - 320 mm (KB 300 mm)
	Y LW - 295 mm (KB 275 mm)	Z 177 mm (KB 300 mm)	
	Z 152 mm (KB 275 mm)		
	<b>2a</b> Cross divider connector for BOXSIDE and dividing wall		
	<b>Colours</b>	R7037	
		Nylon	
		Z40H000A	
	<b>2b</b> Cross divider connector for gallery		
	<b>Colours</b>	R7037	
		Nylon	
		Z40H0002.R	
	<b>3</b> Lateral divider		
	<b>Colours</b>	R9006 / WGR	
		Steel	
		Z43H100S.01	
	<b>4</b> Bottle rack		
	<b>Nominal length NL (mm)</b>	<b>Cabinet width KB 275 mm</b>	<b>Cabinet width KB 300 mm</b>
	450		Z48.30B014
	500	Z48.27B016	Z48.30B016
550	Z48.27B017	Z48.30B017	
	<b>5</b> Dividing wall		
	<b>Colours</b>	SW	R9006
	<b>Nominal length NL (mm)</b>	Steel	
	450	Z46C420S.E2	
	500	Z46C470S.E2	
550	Z46C520S.E2		

KB	Cabinet width
LW	Internal cabinet width

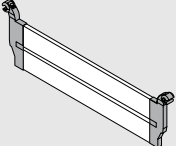
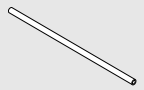

Gallery

Ordering information

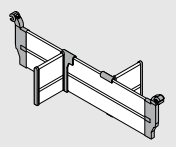
Cross divider cut to size and pre-mounted gallery connections			
	Colours	R9006 / WGR	
	Cabinet width KB (mm)	Steel	
	300	Z40H177S.R	
	350	Z40H277S.R	
	400	Z40H277S.R	
	450	Z40H327S.R	
	500	Z40H377S.R	
	800	Z40H677S.R	
	900	Z40H777S.R	
	1000	Z40H877S.R	
1200	Z40H1077S.R		
Cross gallery for cutting to size			
	Colours	SW	R9006
	Cabinet width KB (mm)	Aluminium	
	up to 1200	ZRG.1094U	
	Cutting:	Internal cabinet width LW - 68 mm	
Cross gallery connector			
	Colours	SW	R9001 R7037
		Nylon	
		ZRU.00Z0.01	
Lateral divider for cross gallery			
	Colours	SW	R9001 R7037
		Nylon	
		ZRU.00F0	
Cross and lateral divider set for gallery			
	Colours	R9006 / WGR	
	Cabinet width KB (mm)	Steel	
	450	ZFI.45RVS6A	
	800	ZFI.80RVS6	
	900	ZFI.90RVS6	
	1000	ZFI.10RVS6	
1200	ZFI.12RVS6		



**BOXSIDE**

**Ordering information**

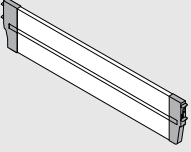
Cross divider pre-mounted for BOXSIDE		
	<b>Colours</b>	R9006 / WGR
	<b>Cabinet width KB (mm)</b>	Steel
	300	Z40H177S
	400	Z40H277S
	450	Z40H327S
	500	Z40H377S
	800	Z40H677S
	900	Z40H777S
	1000	Z40H877S
	1200	Z40H1077S

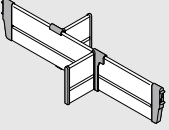
Cross and lateral divider set for BOXSIDE		
	Nominal length NL 450 mm	
	<b>Colours</b>	R9006 / WGR
	<b>Cabinet width KB (mm)</b>	Steel
	300	ZFI.30BUS4
	400	ZFI.40BUS4
	450	ZFI.45BUS4
	500	ZFI.50BUS4
	550	ZFI.55BUS4
	800	ZFI.80BUS4
	900	ZFI.90BUS4
1000	ZFI.10BUS4	
1200	ZFI.12BUS4	

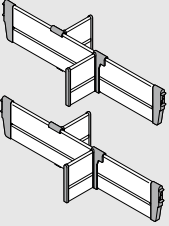
Cross and lateral divider set for BOXSIDE		
	Nominal length NL 500–650 mm	
	<b>Colours</b>	R9006 / WGR
	<b>Cabinet width KB (mm)</b>	Steel
	300	ZFI.30BUS6
	400	ZFI.40BUS6
	450	ZFI.45BUS6
	550	ZFI.55BUS6
	800	ZFI.80BUS6
	900	ZFI.90BUS6
	1000	ZFI.10BUS6
1200	ZFI.12BUS6	

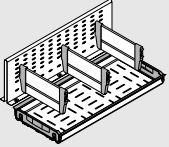
Bottle set with cross dividers and a dividing wall		
	<b>Colours</b>	R9006 / WGR
	<b>Nominal length NL (mm)</b>	Steel
	450	ZFI.30BZS4N
	500	ZFI.30BZS6N
	550	ZFI.30BZS7N

**Description**



- The film/foil dispenser for plastic wrap and aluminium foil for easy tangle-free dispensing
- Knife holder for safe storage of knives in the drawer
- Plate holder for easy transport and secure storage in the pull-out
- Spice holder for storage and easy access to spice containers of all sizes
- Also available as a practical complete set

**Ordering information**

**Knife holder**

For 9 knives

	<b>ZSZ.02M0</b>
--	-----------------

**Film/foil dispenser**

For cling film

Incl. film	<b>ZSZ.01F0</b>
Without film	<b>ZSZ.01F1</b>

**Film/foil dispenser**

For aluminium foil

Incl. foil	<b>ZSZ.02F0</b>
Without foil	<b>ZSZ.02F1</b>

**Spice holder**

Cabinet width

300 mm (width 212 mm)	<b>ZFZ.30G01</b>
400 mm (width 312 mm)	<b>ZFZ.40G01</b>
450 mm (width 362 mm)	<b>ZFZ.45G01</b>

**Plate holder**

Ø plates 186 – 322 mm	<b>ZC7T0350</b>
Overall height 170 mm	
Stacking height – up to 12 plates	

**Kitchen accessory set**

Set	<b>ZOU.30U11</b>
<b>Consisting of:</b>	
<b>1 x</b>	Knife holder
<b>1 x</b>	Film dispenser for cling film (incl. film)
<b>1 x</b>	Foil dispenser for aluminium foil (incl. foil)
<b>2 x</b>	Spice holder (for cabinet width of 300 mm)
<b>2 x</b>	Plate holder

Julius Blum GmbH  
Furniture Fittings Mfg.  
6973 Höchst, Austria  
Tel.: +43 5578 705-0  
Fax: +43 5578 705-44  
E-mail: [info@blum.com](mailto:info@blum.com)  
[www.blum.com](http://www.blum.com)

Our sites in Austria, Poland and China are certified to the international standards mentioned below.  
Our site in the USA is certified to ISO 9001.  
Our site in Brazil is certified to ISO 9001, ISO 14001 and ISO 45001.



**ISO 9001**  
Certified Quality  
System



**ISO 14001**  
Certified Environmental  
System



**ISO 50001**  
Certified Energy  
System

 **blum**®



Look for our  
FSC™-certified  
products

All content is copyrighted by Blum.  
Subject to technical modifications and changes to the range without notice.  
TD-068/3 EN-AL/08.23